



Time for Progress...

Rubber screens



**Sieves and screen decks
specialized producer**

WEDGE WIRE SCREENS & TUBES
WOVEN WIRE MESH & SCREENS
FINE WIRE MESH
HARP & PIANO SCREENS
FINGER SCREENS
PERFORATED SCREENS
RUBBER SCREENS
POLYURETHANE SCREENS

www.progress-screens.com

RUBBER SCREENS

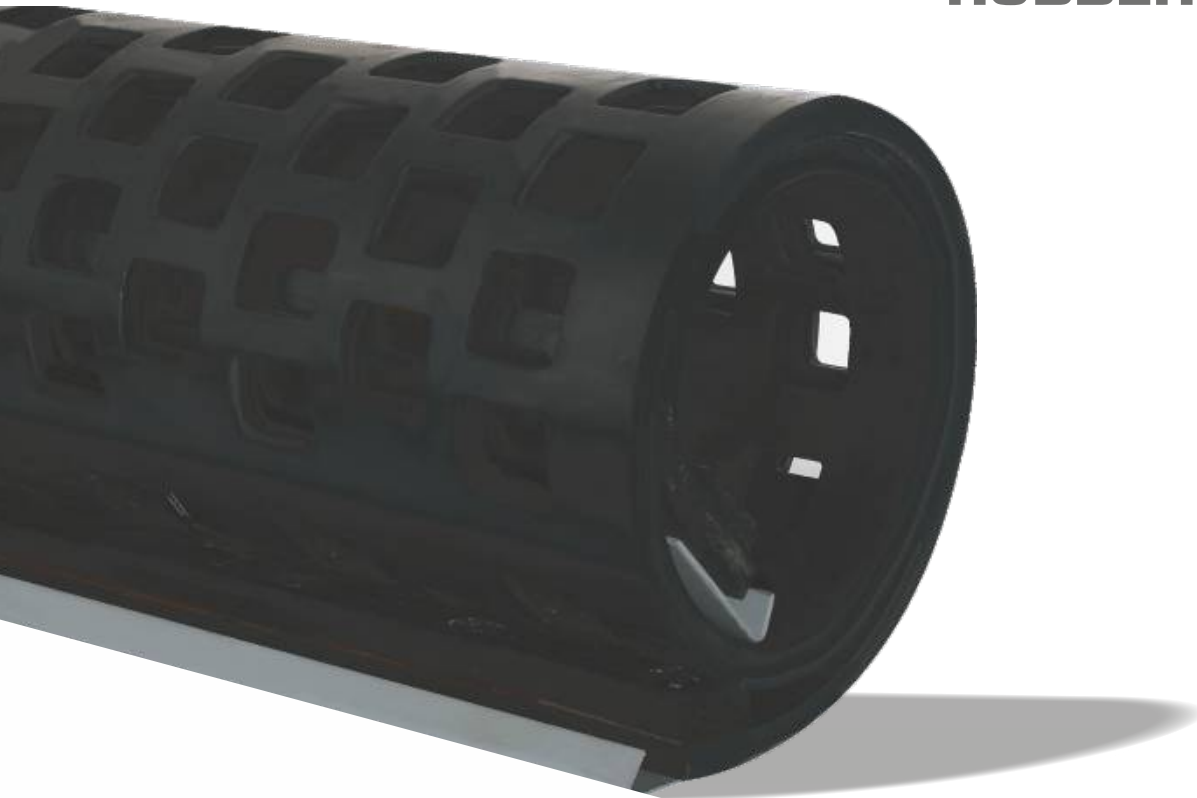

Progress ECOGUM rubber screens are produced for all types of sorting equipment. Designed mainly to sort products ranging from 4 up to 200mm. Modern production technology and high class rubber compounds, allow to choose from a large variety of thickness measurements, bridge wideness and opening placements, depending on screen's usage and requirements. The thickness can be from 5 up to 60mm. There are 3 available versions: in round, square or rectangular shapes. Mat thickness can be from 5 up to 60mm, and is produced in three versions:



TENSIONED RUBBER SCREENS WITH CORD REINFORCEMENT

Their main advantage is the ability of substituting wire screens without changing the underscreen construction. Mainly used when screen plugging appears and high effectiveness is required. They are side and end tensioned. Produced from abrasion resistant rubber, reinforced with a cord, suitable for all types of vibrating screening machines.

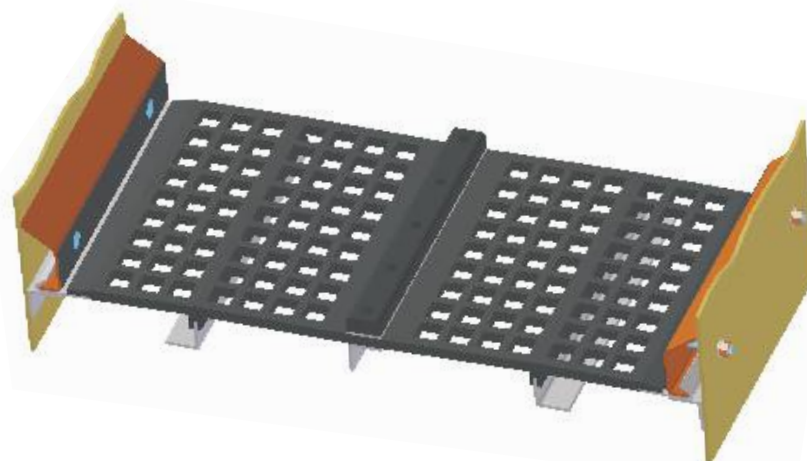

Tensioned screens are available with following tensioning systems:

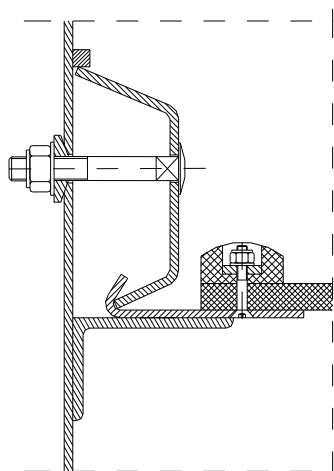

System P-1

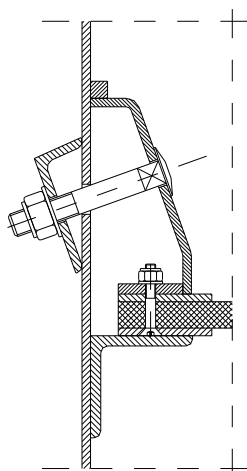

System P-2

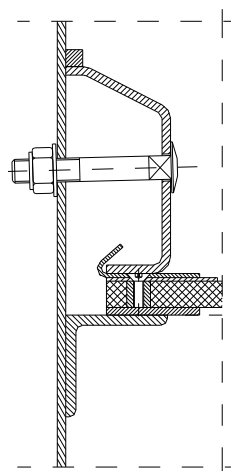

System P-3

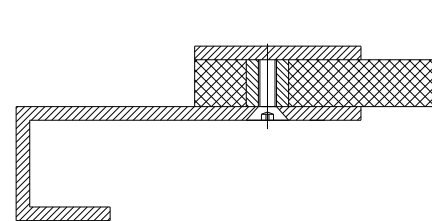

System P-4

RUBBER SCREENS WITH STEEL FRAME AND CORD

REINFORCEMENT can pose as a self – supporting deck, suitable for tougher work conditions – mainly for big fractions classification. They are mounted using side rubber bars.

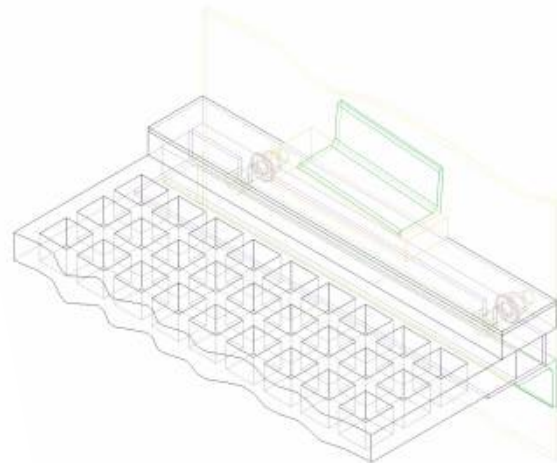
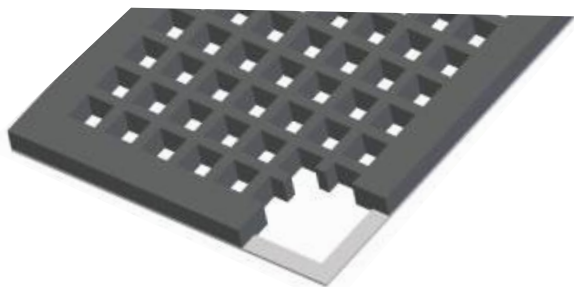

RUBBER SCREENS WITH STEEL FRAME, made of angle bar and steel rods – can also pose as a self – supporting deck, used mainly for prescreening in tough conditions. They are mounted using side rubber rods.

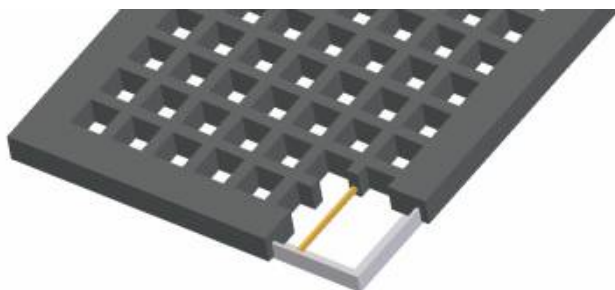

PROGRESS rubber screens dimensions are individually adapted for machine dimensions and work conditions. They are particularly recommended for prescreening machines, working in continuous cycle.

Our offer also includes rubber lining, which can be used for example inside loads or charging hoppers.

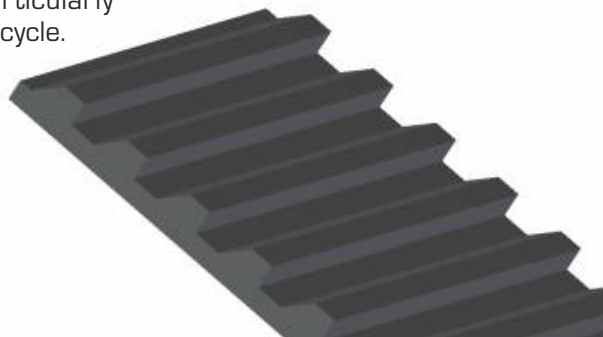



Time for Progress...



Sieves and screen decks
specialized producer

Progress Eco

Dobrow 7,
28-142 Tuczępy, PL
tel: +48 15 864 62 70
fax: +48 15 864 62 78
office@progress-screens.com

Office Kielce

ul. Trzuskawicka 16
25-801 Kielce, PL
tel/fax: +48 41 346 50 06
tel/fax: +48 41 345 50 08
kielce@progress-screens.com

Office Katowice

ul. Zbożowa 38
40-657 Katowice, PL
tel: +48 32 202 25 44
fax: +48 32 202 25 44
katowice@progress-screens.com

www.progress-screens.com